

owners guide

10" (254 mm) BAND SAW

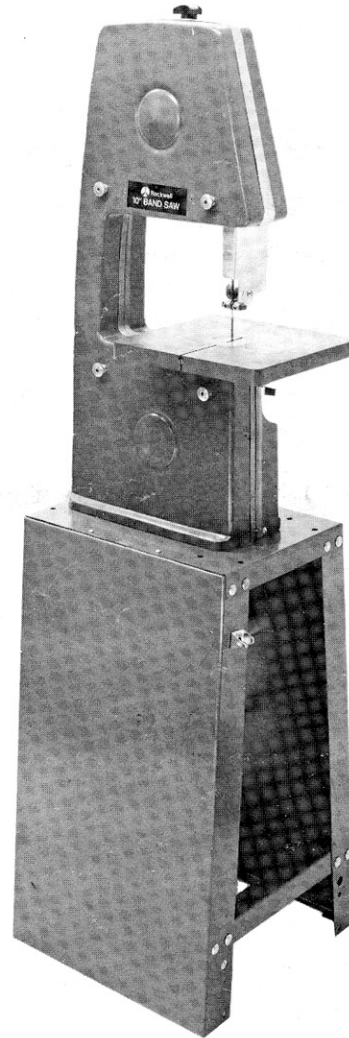

The Serial No. and Model No. plate is attached to the top surface of the frame casting. This plate can be seen by removing the front guard and looking behind the left edge of the upper blade wheel. Locate this plate and record the Serial No. and Model No. in your manual for future reference.

SERIAL NO. _____

MODEL NO. _____

SAFETY RULES FOR ALL TOOLS

As with all power tools there is a certain amount of hazard involved with the operator and his use of the tool. Using the tool with the respect and caution demanded as far as safety precautions are concerned will considerably lessen the possibility of personal injury. However, if normal safety precautions are overlooked or completely ignored, personal injury to the operator can develop.

There are also certain applications for which this tool was designed. Rockwell strongly recommends that this tool NOT be modified and/or used for any application other than for which it was designed. If you have any questions relative to its application DO NOT use the tool until you have written Rockwell and we have advised you.

ROCKWELL INTERNATIONAL
MANAGER OF PRODUCT SAFETY
POWER TOOL DIVISION
400 NORTH LEXINGTON AVENUE
PITTSBURGH, PENNSYLVANIA 15208

- 1. KNOW YOUR POWER TOOL.** Read the owner's manual carefully. Learn the tools applications and limitations, as well as the specific potential hazards peculiar to it.
- 2. KEEP GUARDS IN PLACE** and in working order.
- 3. GROUND ALL TOOLS.** If tool is equipped with three-prong plug, it should be plugged into a three-hole electrical receptacle. If an adapter is used to accommodate a two-prong receptacle, the adapter lug must be attached to a known ground. Never remove the third prong.
- 4. REMOVE ADJUSTING KEYS AND WRENCHES.** Form habit of checking to see that keys and adjusting wrenches are removed from tool before turning it on.
- 5. KEEP WORK AREA CLEAN.** Cluttered areas and benches invite accidents.
- 6. AVOID DANGEROUS ENVIRONMENT.** Don't use power tools in damp or wet locations, or expose them to rain. Keep work area well lighted.
- 7. KEEP CHILDREN AND VISITORS AWAY.** All children and visitors should be kept a safe distance from work area.
- 8. MAKE WORKSHOP KIDPROOF** - with padlocks, master switches, or by removing starter keys.
- 9. DON'T FORCE TOOL.** It will do the job better and be safer at the rate for which it was designed.
- 10. USE RIGHT TOOL.** Don't force tool or attachment to do a job it was not designed for.
- 11. WEAR PROPER APPAREL.** No loose clothing, gloves, neckties, or jewelry to get caught in moving parts. Non-slip footwear is recommended. Wear protective hair covering to contain long hair.
- 12. USE SAFETY GLASSES.** Also use face or dust mask if cutting operation is dusty.
- 13. SECURE WORK.** Use clamps or a vise to hold work, when practical. It's safer than using your hand and frees both hands to operate tool.
- 14. DON'T OVERREACH.** Keep your proper footing and balance at all times.
- 15. MAINTAIN TOOLS IN TOP CONDITION.** Keep tools sharp and clean for best and safest performance. Follow instructions for lubricating and changing accessories.
- 16. DISCONNECT TOOLS** before servicing and when changing accessories such as blades, bits, cutters.
- 17. USE RECOMMENDED ACCESSORIES.** Consult the owner's manual for recommended accessories. The use of improper accessories may cause hazards.
- 18. AVOID ACCIDENTAL STARTING.** Make sure switch is in "OFF" position before plugging in cord.
- 19. NEVER STAND ON TOOL.** Serious injury could occur if the tool is tipped or if the cutting tool is accidentally contacted.
- 20. CHECK DAMAGED PARTS.** Before further use of the tool, a guard or other part that is damaged should be carefully checked to ensure that it will operate properly and perform its intended function - check for alignment of moving parts, binding of moving parts, breakage of parts, mounting, and any other conditions that may affect its operation. A guard or other part that is damaged should be properly repaired or replaced.
- 21. DIRECTION OF FEED.** Feed work into a blade or cutter against the direction of rotation of the blade or cutter only.
- 22. NEVER LEAVE TOOL RUNNING UNATTENDED. TURN POWER OFF.** Don't leave tool until it comes to a complete stop.
- 23. DRUGS, ALCOHOL, MEDICATION.** Do not operate tool while under the influence of drugs, alcohol or any medication.

ADDITIONAL SAFETY RULES FOR BAND SAWS

- 1. ADJUST** the upper guide about 1/8" above the material being cut.
- 2. MAKE SURE** that blade tension and blade tracking are properly adjusted.
- 3. STOP** the machine before removing scrap pieces from the table.
- 4. ALWAYS** keep hands and fingers away from blade.
- 5. CHECK** for proper blade size and type.
- 6. DO NOT** attempt to saw stock that does not have a flat surface, unless a suitable support is used.
- 7. HOLD** material firmly and feed into blade at a moderate speed.
- 8. TURN OFF** machine if the material is to be backed out of an uncompleted cut.
- 9. MAKE** "release" cuts before cutting long curves.

INTRODUCTION

Your new Band Saw will accurately perform all the usual woodworking band saw operations; straight cutting, curve cutting, cutting plastics and light aluminum, etc. In addition, by using the Accessory Sanding Attachment in place of the blade, you can sand irregular curved work previously cut on the band saw to add that professional finished look to your work.

TOOLS NEEDED FOR ASSEMBLY AND ADJUSTMENTS

Your band saw can be assembled and adjusted using a few basic hand tools including:

Flat Blade Screwdriver
7/16" Open End Wrench
1/4" Open End Wrench
5/32" Allen Wrench

UNPACKING

Carefully unpack the band saw and all loose items from the carton. Fig. 1 illustrates the machine removed from the carton along with the 2-3/4" dia., 5/8" bore motor pulley (A) and the 44-1/8" O.C. V-belt (B), supplied with the band saw. Note that the band saw table is tilted for packing purposes.

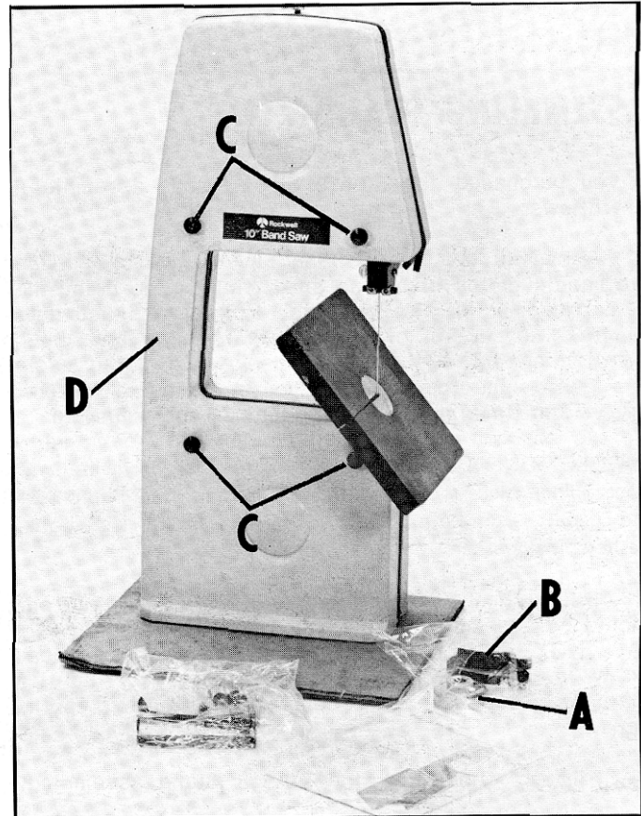

Fig. 1

SETTING UP

1. Remove the four knobs and washers (C) Fig. 1, and the front wheel guard (D).
2. Fig. 2 illustrates the knobs and washers (C) and front wheel guard (D) removed.
3. Remove the four hex nuts and washers holding the band saw to the cardboard base and lift the machine off the base. Two of the hex nuts and washers (E) are shown in Fig. 2.

CLEANING

Remove the protective coating from the machined surfaces of the band saw. This coating may be removed with a soft cloth moistened with kerosene (do not use acetone, gasoline or lacquer thinner for this purpose). After cleaning, cover all unpainted surfaces with a good quality paste wax.

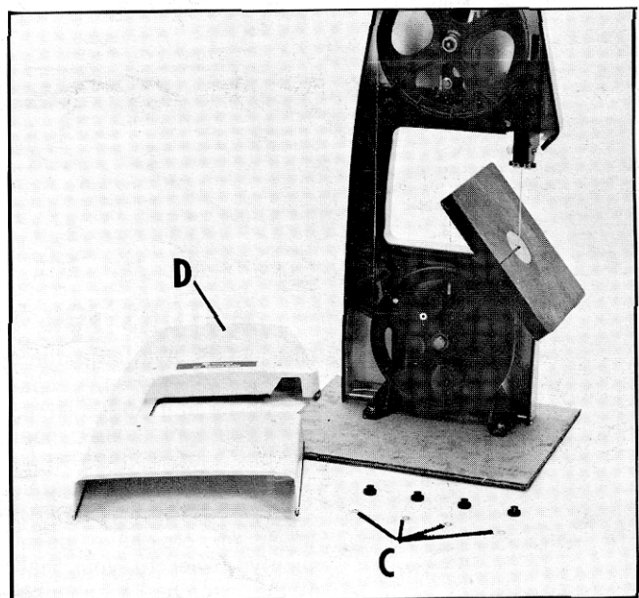

Fig. 2

ASSEMBLING STAND

If you purchased the 50-518 Steel Stand, assemble it as follows:

1. Assemble the top shelf and the two braces to the two panels of the stand, as shown in Fig. 3, using the 16 carriage bolts, flat washers, lockwashers and nuts supplied.

2. Fasten the top shelf to the panels using the four screws and tinnerman nuts supplied, as shown in Fig. 3.

SUGGESTION: Do not tighten nuts until all hardware is in place. Then place stand on a flat surface and square up braces and panels, etc. before final tightening of carriage bolts, washers, lockwashers and nuts.

3. Four rubber feet are supplied with the stand and should be assembled to the stand as illustrated in Fig. 3A. **NOTE:** It is necessary to seat the truss head screw in the recess of the rubber foot by giving it a sharp blow with a hammer before assembling to the stand.

4. Fig. 4, illustrates the 50-518 Stand assembled.

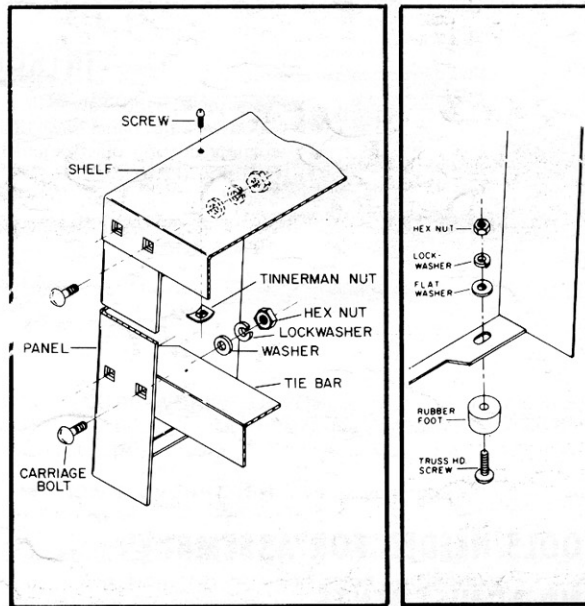

Fig. 3

Fig. 3A

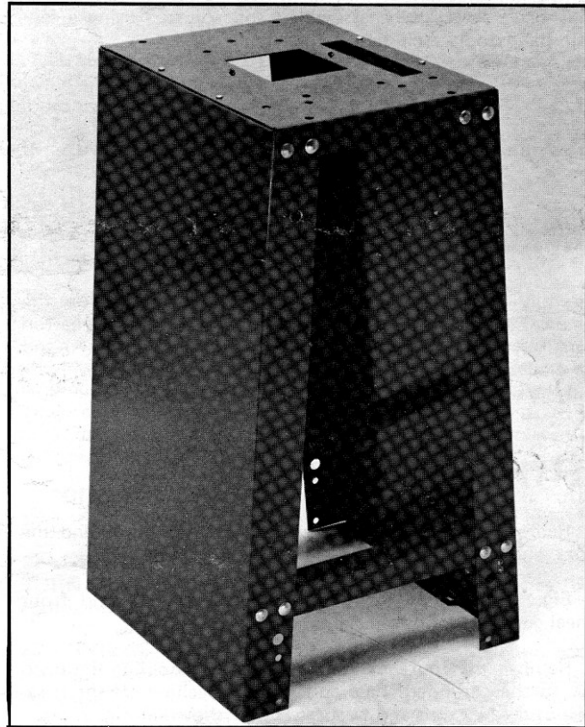

Fig. 4

MOTORS FOR YOUR BAND SAW

The motors available for use with your band saw are:
 62-142, 1/2 H.P. heavy duty, (ball bearing), capacitor start, 1725 RPM, 115 Volt
 62-134, 1/3 H.P. heavy duty, (ball bearing), capacitor start, 1725 RPM, 115/Volt
 62-133, 1/3 H.P. standard duty, (sleeve bearing), split phase, 1725 RPM, 115 Volt

These motors have been specially selected to best supply power to your machine and the relative safety of the machine is enhanced by their use. We therefore strongly suggest that only these motors be used as the use of other motors may be detrimental to the performance and safety of your band saw.

ASSEMBLING MOTOR MOUNTING HINGE BRACKET

If you purchased the 50-512 Motor Mounting Hinge Bracket assemble it using the two screws, two nuts and four washers, as shown in Fig. 5.

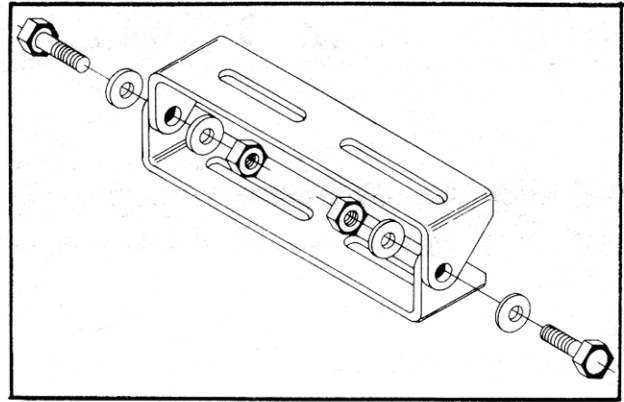

Fig. 5

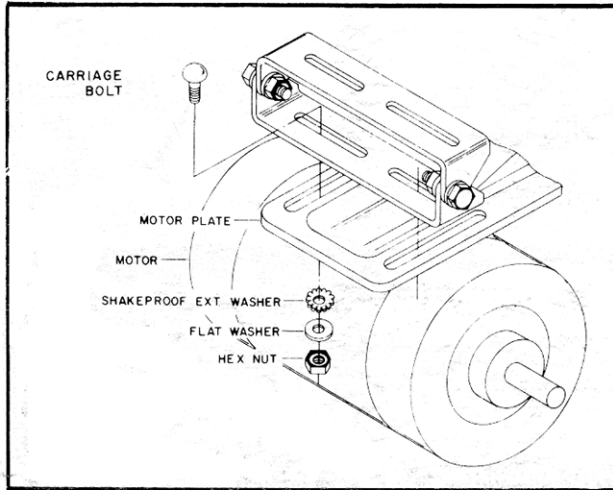

Fig. 6

ASSEMBLING MOTOR TO HINGE BRACKET

Make sure the motor is DISCONNECTED from the power source and assemble the motor to the mounting hinge bracket using the two carriage bolts, two flat washers, two shakeproof external lockwashers and two nuts supplied, as shown in Fig. 6. **CAUTION:** The proper grounding of the motor, to prevent shock hazard, depends on the use of the shakeproof external lockwashers in the manner shown in Fig. 6.

ASSEMBLING BAND SAW AND MOTOR AND HINGE BRACKET TO STAND

Place the band saw on the top shelf of the stand, lining up the four holes in the band saw base with the four holes (A) and (B) Fig. 7, in the top of the shelf. Fasten the rear base of the band saw to the two holes (B) Fig. 7, of the shelf, using the two hex head screws, four flat washers, four external tooth lockwashers and two hex nuts supplied. Make sure the motor is DISCONNECTED from the power source and hold the motor and hinge bracket assembly in place under the two holes (A) Fig. 7, of the top shelf. Assemble the band saw and motor and hinge bracket assembly to the two holes (A) Fig. 7, in the top shelf of the stand using the two hex head screws, four flat washers, four external tooth lockwashers and two hex nuts, as shown in Fig. 8. **CAUTION:** The proper grounding of the motor to prevent shock hazard, depends on the use of the shakeproof lockwashers in the manner shown in Fig. 8.

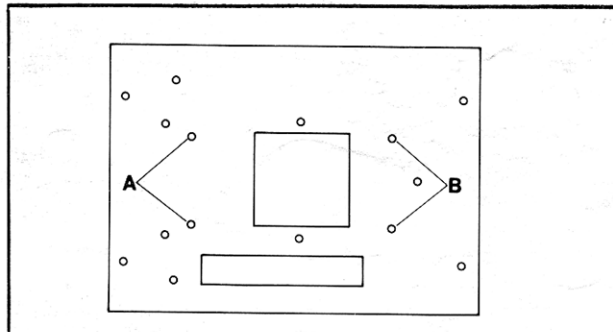

Fig. 7

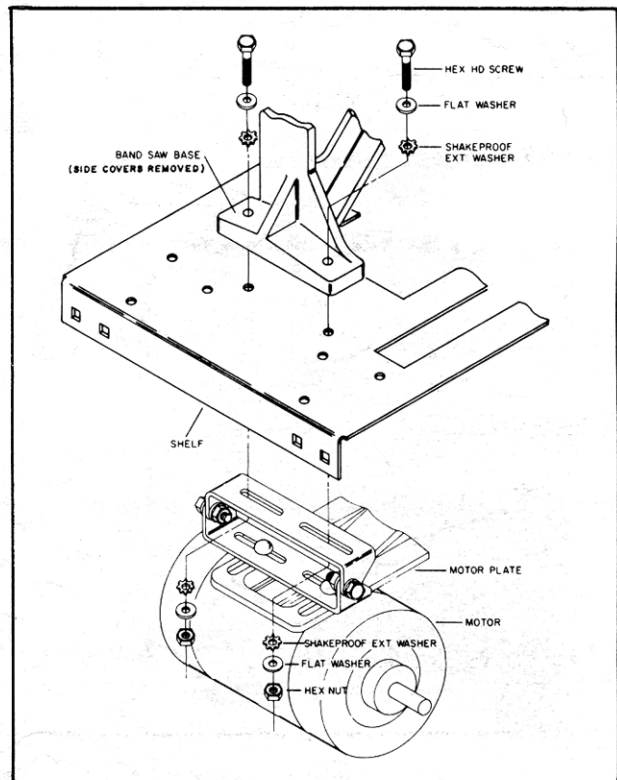

Fig. 8

ASSEMBLING SWITCH TO STAND

If you purchased one of the motors recommended for use with your band saw, you received a switch and cord set connected to the motor. Assemble the switch to the stand as follows:

1. **IMPORTANT:** When assembling the switch to the stand, **MAKE SURE** the motor power cord is **NOT** connected to the power source.
2. Remove the outer hex nut (A) Fig. 9, from the switch stem. Leave shakeproof lockwashers (B) and inside hex nut (C) on switch stem. **CAUTION:** The proper grounding of the switch to prevent shock hazard, depends on the use of the shakeproof lockwashers in the manner shown.
3. Determine which panel of the stand you wish to assemble the switch and remove the round knockout located on the panel.
4. Insert switch stem through hole in panel of stand making sure the keyway in the switch stem is in the down position.
5. Place the switch bracket (C) Fig. 10, on switch stem with key in switch bracket engaged with keyway in switch stem and fasten in place with hex nut (A) that was removed in STEP 2. **NOTE:** The excess wire from the motor to the switch should be wrapped and tied and then positioned out of the way.
6. **IMPORTANT:** We suggest that when the band saw is not in use, the switch be locked in the "OFF" position using a padlock, as shown in Fig. 11. Catalog No. 49-031 Pad'lock is available as an accessory.

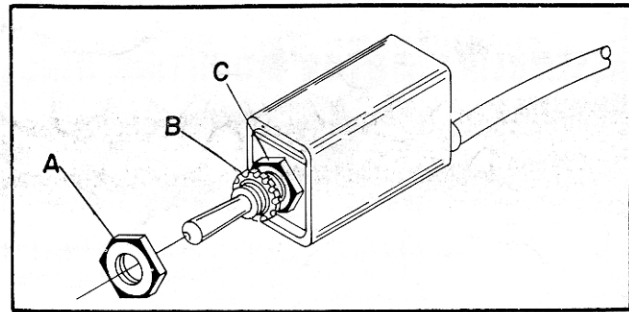

Fig. 9

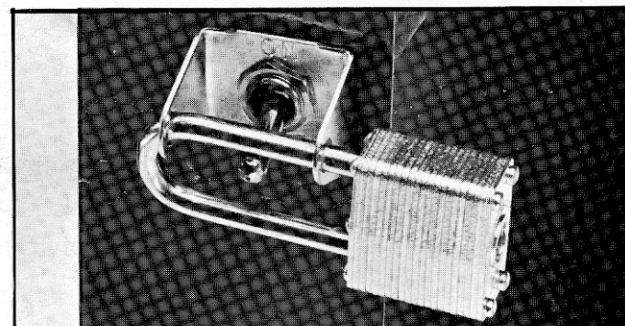
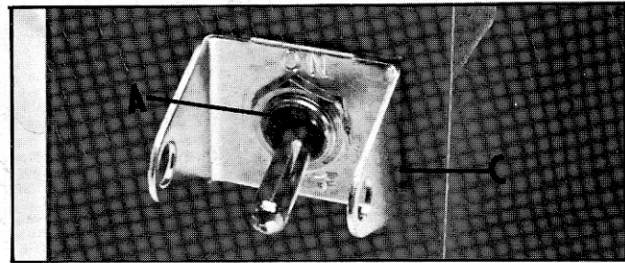

Fig. 11

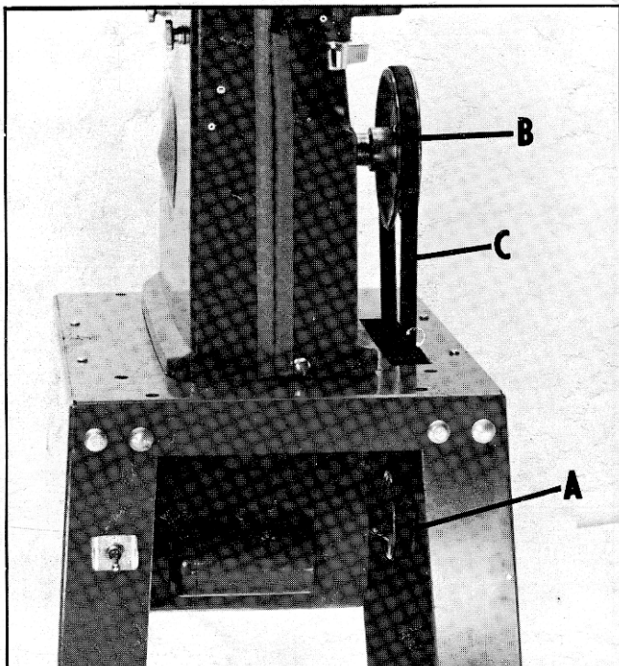

Fig. 12

ASSEMBLING MOTOR PULLEY AND V-BELT

1. Assemble the motor pulley (A) Fig. 12, to the motor shaft with the hub of the pulley in the out position. Using a straight edge, align the motor (A) to the driven pulley (B) and tighten set screw in the motor pulley against the key in the motor shaft.
2. Assemble V-Belt (C) to the motor pulley and driven pulley, as shown in Fig. 12.

ASSEMBLING BAND SAW TO BENCH

If the band saw is to be used without the Steel Stand, we suggest that it always be fastened to a supporting surface using the holes in the band saw base. Fig. 13, illustrates the size and center to center distance of the holes to be drilled in the supporting surface.

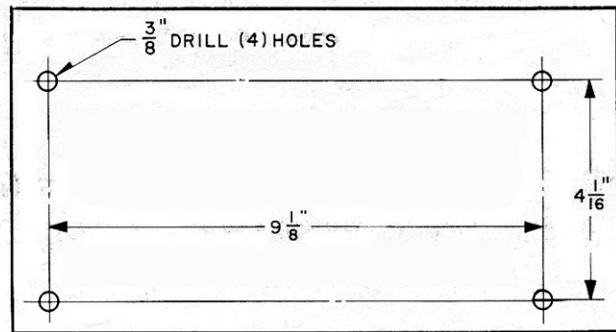

Fig. 13

FASTENING STAND OR BENCH TO FLOOR

IF DURING OPERATION THERE IS ANY TENDENCY FOR THE TOOL TO TIP OVER, SLIDE OR WALK ON SUPPORTING SURFACE, THE STAND OR BENCH MUST BE SECURED TO THE FLOOR.

CONNECTING BAND SAW TO POWER SOURCE

POWER CONNECTIONS

A separate electrical circuit should be used for your power tools. This circuit should not be less than #12 wire and should be protected with a 20 Amp time lag fuse. If an extension cord is used, use only 3-wire extension cords which have 3-prong grounding type plugs and 3-pole receptacles which accept the tools plug. For distances up to 100 feet use #12 wire. For distances up to 150 feet use #10 wire. Before connecting the motor to the power line, make sure the switch is in the "OFF" position and be sure that the electric current is of the same characteristics as stamped on motor nameplate. All line connections should make good contact. Running on low voltage will injure the motor.

GROUNDING INSTRUCTIONS

This tool must be grounded while in use to protect the operator from electric shock. The recommended motors are shipped wired for 115 Volt, Single Phase and are equipped with an approved 3-conductor cord and 3-prong grounding type receptacle, as shown in Fig. 14. The green conductor in the cord is the grounding wire. Never connect the green wire to a live terminal.

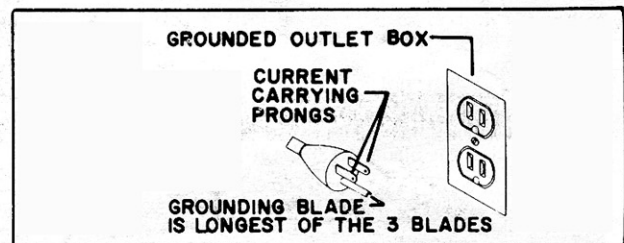

Fig. 14

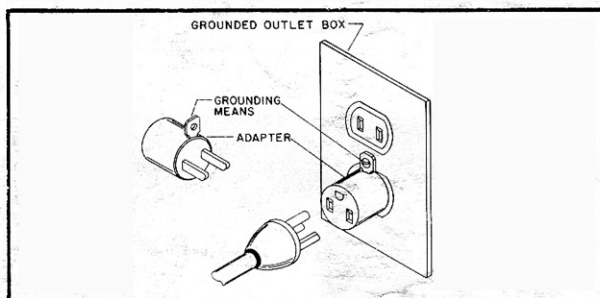

Fig. 15

An adapter, shown in Fig. 15, is available for connecting 3-prong grounding type plugs to 2-prong receptacles. THIS ADAPTER IS NOT APPLICABLE IN CANADA. The green-colored rigid ear, lug, etc., extending from the adapter is the grounding means and must be connected to a permanent ground such as to properly grounded outlet box, as shown in Fig. 15.

IMPORTANT: IN ALL CASES, MAKE SURE THE RECEPTACLE IN QUESTION IS PROPERLY GROUND-ED. IF YOU ARE NOT SURE HAVE A CERTIFIED ELECTRICIAN CHECK THE RECEPTACLE.

OPERATING ADJUSTMENTS

Although your band saw is checked and adjusted at the factory, it may have come out of adjustment during transit. To check and adjust the band saw, proceed as follows:

ADJUSTING BLADE TENSION

1. Loosen thumb screw (A) Fig. 16, and move the upper blade guide (B), to the highest position.
2. Turn the tension adjusting screw (C) Fig. 16, clockwise to increase or counterclockwise to decrease blade tension.
3. Proper blade tension is obtained when the blade has a flex of approximately 1/4" in a 6" span.
4. When the band saw is not in use it is good practice to release tension to prolong the life of the blade.

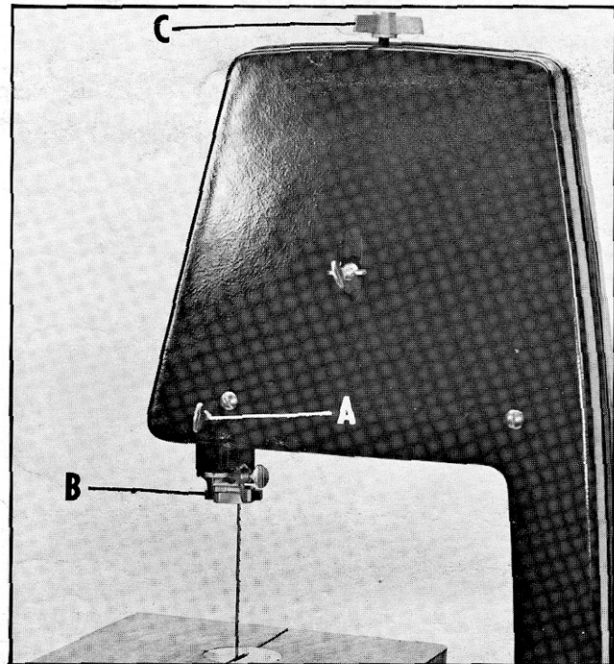

Fig. 16

TRACKING THE BLADE

For accurate work and maximum blade life, it is important that the blade be centered on the upper wheel. When this adjustment has been properly made, the blade will "track". If it is, it will run steadily in the same line. Before the tracking adjustment is made, both the upper and lower blade guides must be moved away from the blade. To "track" the blade, proceed as follows:

1. Disconnect the band saw from the power source and make sure the correct blade tension is applied to the blade.
2. Remove the front guard and turn the upper wheel (A) slowly by hand to determine if the blade (B) is riding in the center of the wheel as shown in Fig. 17.
3. If the blade is not riding in the center of the wheel, loosen locknut (E) Fig. 17, and while turning the wheel by hand, turn the adjusting screw (F) slightly to the left. You will notice that the blade will move to either side of the wheel.
4. When the blade is riding on the center of the upper wheel, tighten locknut (E) Fig. 17.
5. Connect the machine to the power source and jog the motor switch on and off to be certain that proper tracking is being maintained.
6. Then make any minor final adjustments that may be necessary at operating speed.

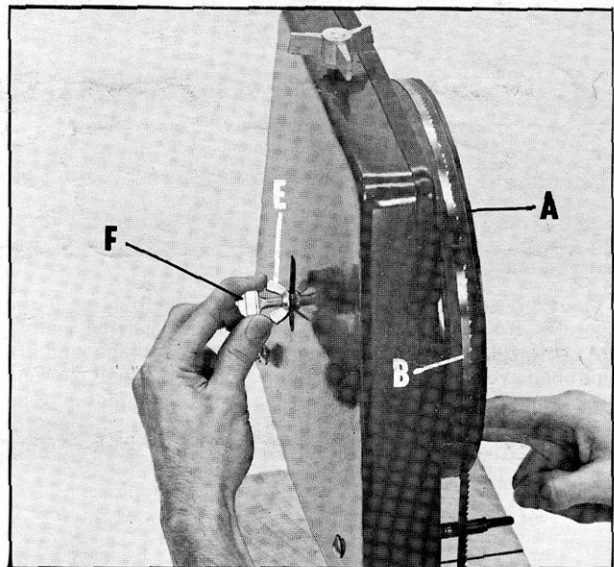

Fig. 17

ADJUSTING UPPER BLADE GUIDE ASSEMBLY

The upper blade guide assembly (B) Fig. 18, should always be set as close as possible to the top surface of the material being cut by loosening thumb screw (A) Fig. 18, and moving the guide assembly (B) to the desired position.

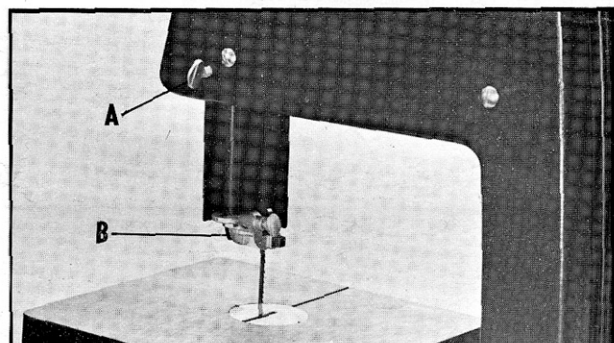

Fig. 18

ADJUSTING UPPER AND LOWER BLADE GUIDES

The upper and lower blade guides are adjusted only after the blade is tensioned and tracking properly. To adjust the guides, proceed as follows:

1. The upper bracket (A) Fig.19, is held to the underneath of the guide post by a cap screw. Loosen the cap screw and move the guide bracket (A) in or out until the front edge of the guides (B) are just behind the "gullets" (bottom of saw teeth).
2. The lower bracket (C) Fig.19, is mounted directly on the base casting by a square head bolt. Loosen the bolt and move the guide bracket (C) in or out until the front edge of the guides (D) are just behind the "gullets" (bottom of the saw teeth).
3. The guides (B) and (D) Fig.19, are held in the guide brackets with set screws (E). Loosen set screws (E) and adjust guides as close as possible to the side of the blade being careful not to pinch the blade.
4. **IMPORTANT:** Set both guides simultaneously so as not to deflect blade.

ADJUSTING BLADE SUPPORT BEARINGS

The support bearings (F) and (G) Fig.19, prevent the blade from being pushed too far to the back which could damage the set in the saw teeth. The support bearings (F) and (G) should be set about 1/64" behind the blade, as follows:

1. Loosen thumb screw (H) Fig.19 and move upper support bearing (F) 1/64" behind the back edge of the blade and tighten thumb screw (H).
2. Loosen set screw (J) and move lower support bearing (G) 1/64" behind the back edge of the blade and tighten set screw (J).

TABLE ADJUSTMENTS

The table tilts 45 degrees to the right and about 10 degrees to the left. To tilt the table, loosen hand knob (A) Fig. 20, tilt table to desired position and tighten hand knob (A).

The band saw is provided with a positive stop that positions the table 90 degrees to the blade. To check and adjust proceed as follows:

1. Loosen hand knob (A) Fig. 20. Move the table until pointer (D) points to the "0" degree mark on the scale and tighten hand knob (A).
2. Place a square on the table with one end of the square against the blade, as shown in Fig. 21. Make sure the blade is at 90 degrees to the table. If it is not, loosen hand knob (A) Fig. 20, and move the table until you are certain the blade is at 90 degrees to the table. Tighten hand knob (A). Then adjust the pointer to the "0" degree mark on the scale.
3. Loosen locknut (B) Fig. 20, and turn the stop screw (C) in or out so that it contacts the frame (E) when the table is at 90 degrees to the blade. Then tighten locknut (B) Fig. 20.
4. If you desire to tilt the table to the left, the stop screw (C) and locknut (B) Fig. 20, must be removed.

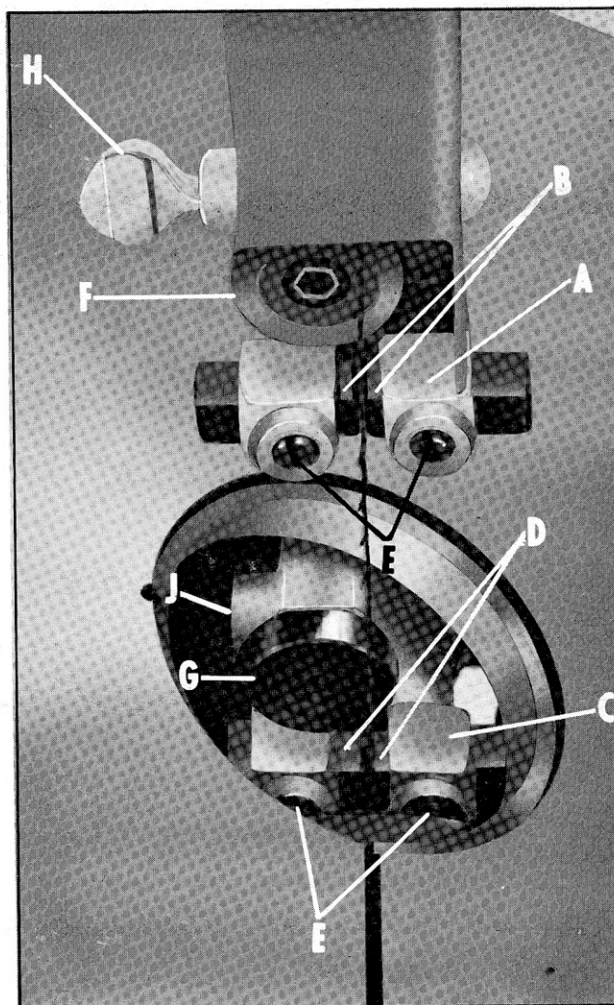

Fig. 19

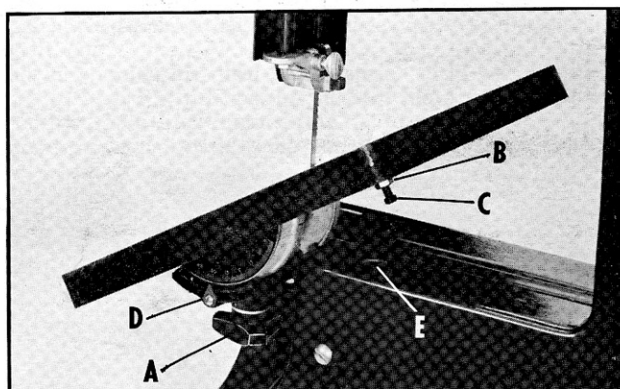

Fig. 20

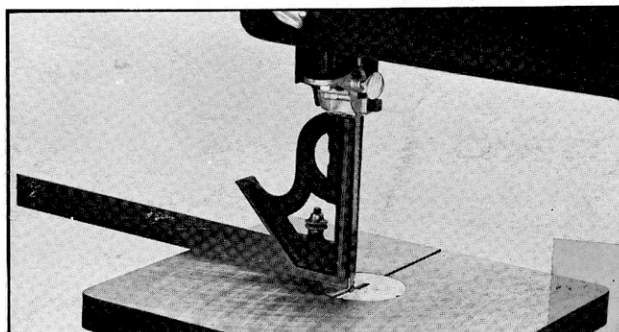

Fig. 21

BLADES

Always use a sharp blade. Keep it free of gum and pitch. Keep the rubber tires free of sawdust, gum and pitch accumulation. Clean frequently with a stiff fiber brush.

Narrow blades are used for cutting small circles or curves while the wider blades are best suited for straight cutting such as ripping.

Neither this band saw nor the blades are recommended for cutting iron or steel.

Due to the low cost of blades it is advisable to purchase new blades rather than attempt to have them sharpened.

Make sure the blade guides are always adjusted properly as outlined previously.

Do not force or twist the blade around a curve or very short radius.

Feed the work uniformly allowing the blade to cut — do not feed too fast.

Do not apply excessive tension on blades. The tension is only necessary to drive the blade without slipping on the wheels. Narrow blades require more tension than wide blades.

INSTALLING THE BLADE

1. Disconnect band saw from power source.
2. Remove front cover of the band saw.
3. Remove table insert (A) and table alignment screw (B) Fig. 22
4. Release blade tension and remove blade as shown in Fig. 23.
5. Check new blade to make sure teeth are pointing in the right direction. If not, turn blade inside out.
6. Place blade on wheels and adjust tracking, tension and guides as previously outlined.
7. Replace table alignment screw (B) and table insert (A) Fig. 22.

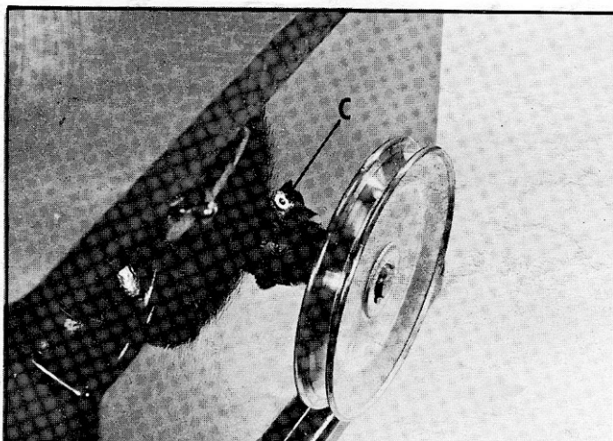

Fig. 24

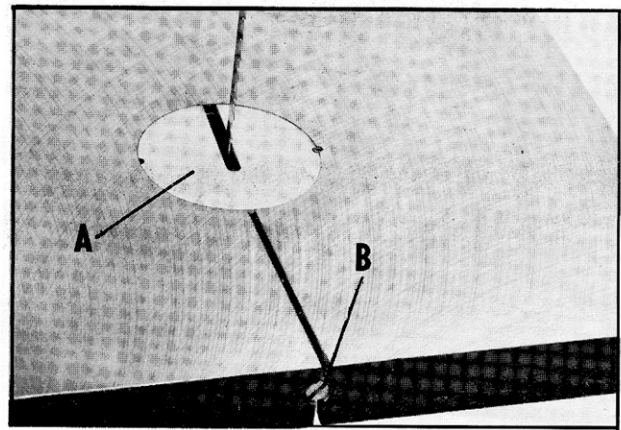

Fig. 22

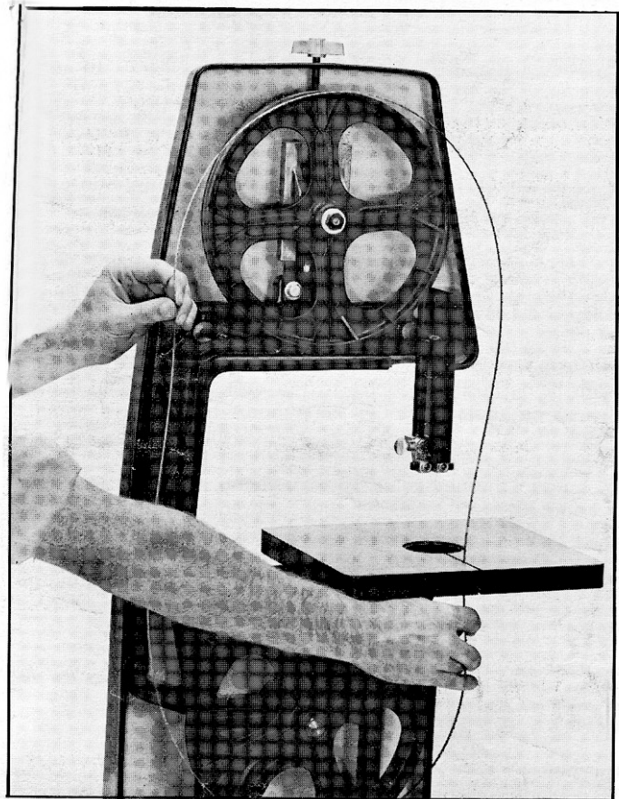

Fig. 23

LUBRICATION

The trunnions on the table should be oiled occasionally so that they operate freely.

The blade support bearings are prelubricated and do not require further lubrication.

The drive shaft runs on bronze bearings. Lubricate occasionally through oiler (C) Fig. 24, using light machine oil.

The upper band saw wheel runs on a bronze bushing. Lubricate occasionally through oiler (A) Fig. 25, using light machine oil.

The sliding ways (B) Fig. 25, of the upper wheel assembly should be oiled occasionally so that they operate freely.

INSTALLING ACCESSORY SANDING ATTACHMENT

1. Assemble the round guides (A) to the sanding platen (D) using the two screws (B) and washers (C), as shown in Fig. 26.
2. Remove the four knurled knobs (A) Fig. 27, and washers, and remove the front cover from the band saw.
3. Remove the table insert and table alignment screw.
4. Release blade tension and remove saw blade from the machine.
5. Remove the lower blade support bearing (B) Fig. 27, from the machine.
6. Loosen screws (C) Fig. 27, remove blade guide (D) and move blade guide (G) to the right out of the way. Follow this same procedure on the lower blade guides.

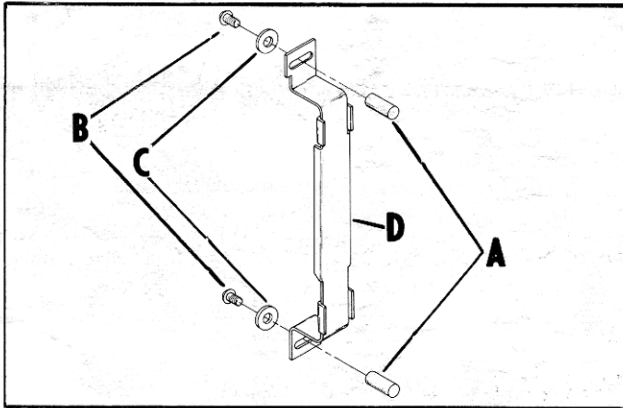

Fig. 26

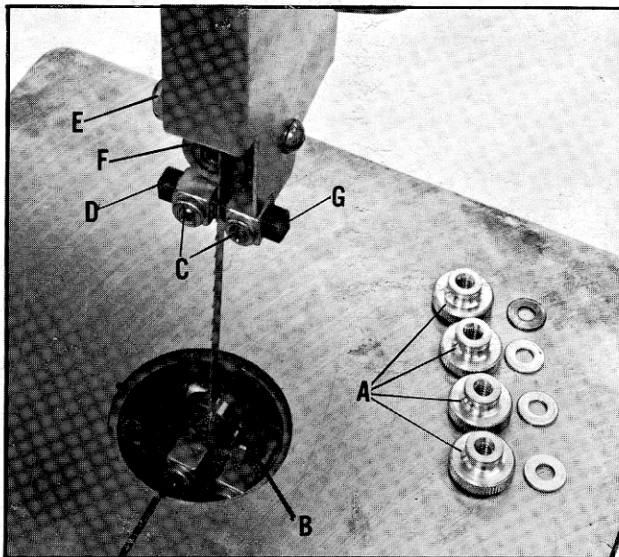

Fig. 27

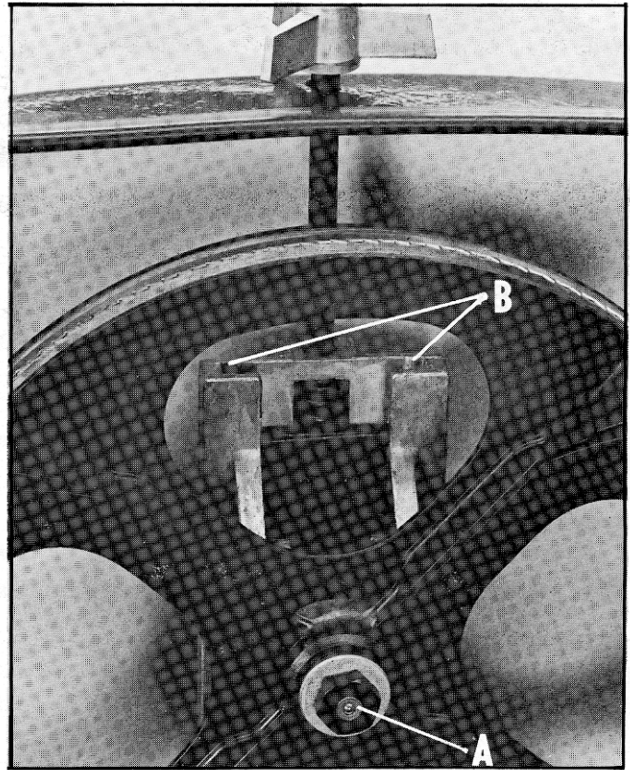

Fig. 25

7. Install sanding belt (A) Fig. 28, to the two wheels. The arrow on the back of the sanding belt indicates the direction of rotation for the belt.
8. Apply light tension and track the belt on the wheels.
9. Adjust the height of the upper blade guide bracket so that the platen guides can be inserted into the upper and lower blade guide slots, as shown in Fig. 28. Position platen (B) so it just touches the sanding belt and tighten two screws (C) Fig. 28.
10. Place the sanding attachment table insert in place in the table and replace the table aligning screw and front cover.

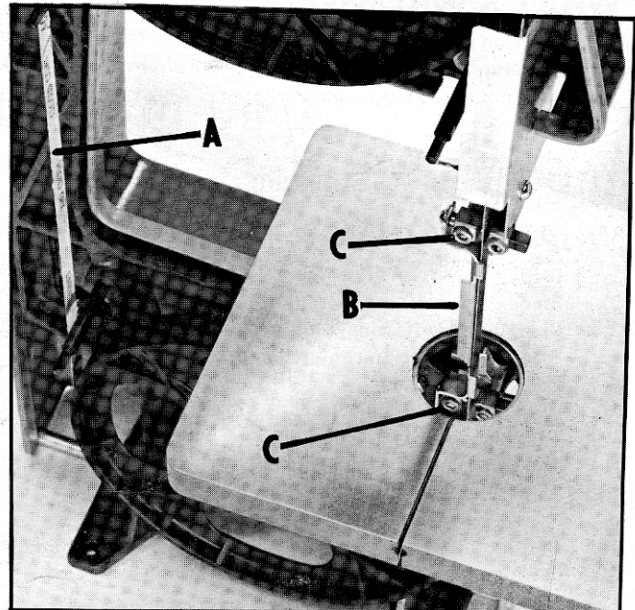

Fig. 28

TROUBLE SHOOTING GUIDE

TROUBLE!! MACHINE WILL NOT START

WHAT'S WRONG?

1. Machine not plugged in
2. Fuse blown or circuit breaker tripped
3. Cord damaged
4. Overload relay not set

WHAT TO DO . . .

1. Plug in machine. See page 7.
2. Replace fuse or reset circuit breaker
3. Have cord replaced by an Authorized Rockwell Service Center or Service Station.
4. Push overload reset button on motor

TROUBLE!! OVERLOAD KICKS OUT FREQUENTLY

WHAT'S WRONG?

1. Extension cord too light or too long
2. Feeding material too fast
3. Low house current

WHAT TO DO . . .

1. Replace with adequate size cord. See page 7.
2. Feed material more slowly
3. Contact your electric company

TROUBLE!! MACHINE VIBRATES EXCESSIVELY

WHAT'S WRONG?

1. Machine not mounted securely to stand or workbench
2. Stand or bench on uneven floor
3. Bad V-belt
4. V-belt not tensioned correctly
5. Bent pulley
6. Motor not fastened securely

WHAT TO DO . . .

1. Tighten all mounting hardware. See pages 4 and 5.
2. Reposition on flat level surface. Fasten to floor if necessary.
3. Replace belt
4. Adjust belt tension by moving motor
5. Replace pulley. See page 6.
6. Tighten all mounting hardware. See page 5.

TROUBLE!! MACHINE DOES NOT COME UP TO SPEED

WHAT'S WRONG?

1. Extension cord too light or too long
2. Low house current
3. Motor not wired for correct voltage

WHAT TO DO . . .

1. Replace with adequate size cord. See page 7.
2. Contact your electric company
3. Refer to motor nameplate for correct wiring

TROUBLE!! BLADES BREAK

WHAT'S WRONG?

1. Blade not tensioned properly
2. Blade guides improperly adjusted
3. Blade support bearing improperly adjusted
4. Blade wheel tracking adjustment improperly set
5. Bad weld on blade
6. Worn tires
7. Forcing wide blade around short radius
8. Dull blade or insufficient set
9. Upper blade guide set too high
10. Continuous running of machine when not actually cutting.

WHAT TO DO . . .

1. Adjust blade tension. See page 8.
2. Check and adjust blade guides. See page 9.
3. Adjust blade support bearing. See page 9.
4. Check and adjust blade tracking. See page 8.
5. Replace the blade. See page 10.
6. Replace tires
7. Change to a narrower blade. See pages 10 and 14.
8. Replace blade. See page 10.
9. Set upper blade guide as close as possible to work. See page 8.
10. Turn off machine when not performing cutting operation

TROUBLE!! BLADE WILL NOT STAY ON WHEEL

WHAT'S WRONG?

1. Blade not tensioned properly
2. Blade guides improperly adjusted
3. Blade support bearing improperly adjusted
4. Blade wheel tracking adjustment improperly set
5. Bad weld on blade
6. Worn tires

WHAT TO DO . . .

1. Adjust blade tension. See page 8.
2. Check and adjust blade guides. See page 9.
3. Adjust blade support bearing. See page 9.
4. Check and adjust blade tracking. See page 8.
5. Replace the blade. See page 10.
6. Replace tires

TROUBLE!! SAW MAKES UNSATISFACTORY CUTS

WHAT'S WRONG?

1. Blade not tensioned properly
2. Blade guides improperly adjusted
3. Blade support bearing improperly adjusted
4. Blade wheel tracking adjustment improperly set
5. Bad weld on blade
6. Worn tires
7. Incorrect blade for work being done
8. Dull blade or insufficient set
9. Upper blade guide set too high
10. Continuous running of machine when not actually cutting.

WHAT TO DO . . .

1. Adjust blade tension. See page 8.
2. Check and adjust blade guides. See page 9.
3. Adjust blade support bearing. See page 9.
4. Check and adjust blade tracking. See page 8.
5. Replace the blade. See page 10.
6. Replace tires
7. Change the blade. See pages 10 and 14.
8. Replace blade. See page 10.
9. Set upper blade guide as close as possible to work. See page 8.
10. Turn off machine when not performing cutting operation

HOW TO ORDER REPLACEMENT PARTS

Even quality built tools such as the Rockwell power tool you have purchased, might need occasional replacement parts to maintain it in good working condition over the years. To order replacement parts, contact or write your nearest Rockwell Service Center listed on the back page of this manual.

Please give the following information:

1. Model No. and Serial No. and all specifications shown on the Model No./Serial No. plate.
2. Part number or numbers as shown in the Replacement Parts list supplied with your power tool.
3. A brief description of the trouble with the power tool.